

Varenummer: 03554060

Beskrivelse: Fluro hydraulik ledhoved FMA 60D

Mål

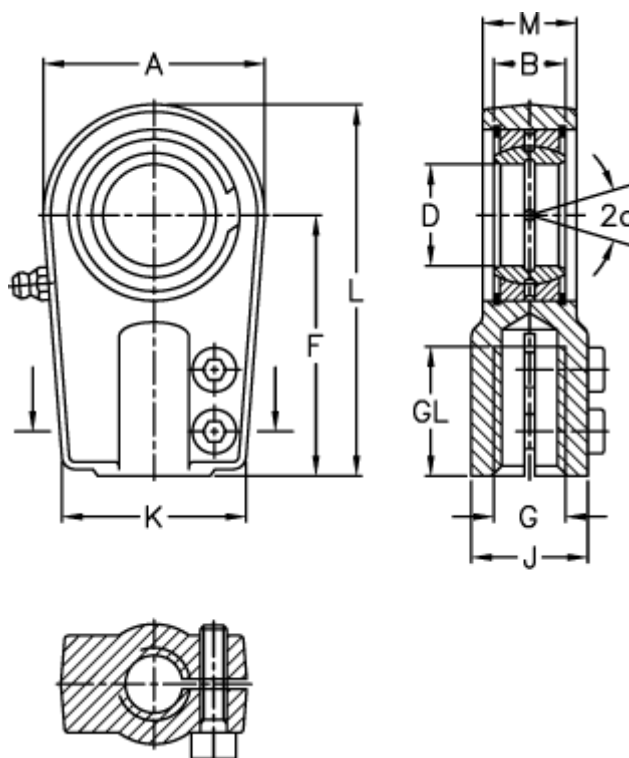

A	= 130	J	= 87
a (grader)	= 7	K	= 118
B	= 44	L	= 240
D	= 60	M	= 50
Dynamisk belastning C (kN)	= 345	Moment (Nm)	= 160
F	= 170	Statisk belastning C0 (kN)	= 539
g	= M64x3	Vægt	= 6500
GL	= 95		